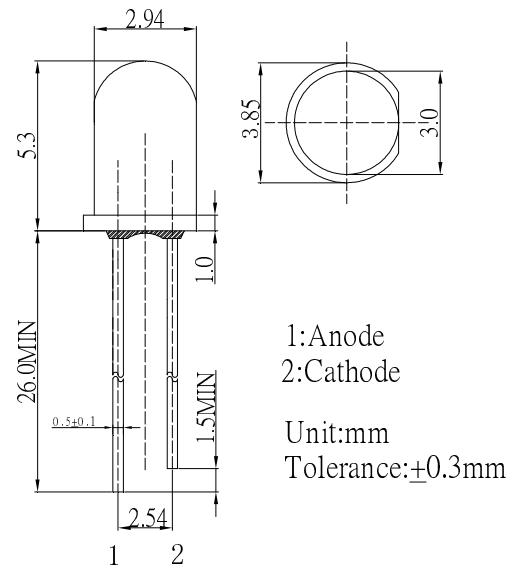

■ Features

- High Luminous LEDs
- 3mm Round Standard Directivity
- Superior Weather-resistance
- UV Resistant Epoxy
- Color Diffused Type

■ Applications

- Electronic Signs And Signals
- Small Area Illuminations
- Back Lighting
- Other Lighting

■ Outline Dimension

■ Absolute Maximum Rating
(Ta=25°C)

Item	Symbol	Value	Unit
DC Forward Current	I_F	30	mA
Pulse Forward Current*	I_{FP}	100	mA
Reverse Voltage	V_R	5	V
Power Dissipation	P_D	108	mW
Operating Temperature	T_{opr}	-30 ~ +85	°C
Storage Temperature	T_{stg}	-40 ~ +100	°C
Lead Soldering Temperature	T_{sol}	260°C/5sec	-

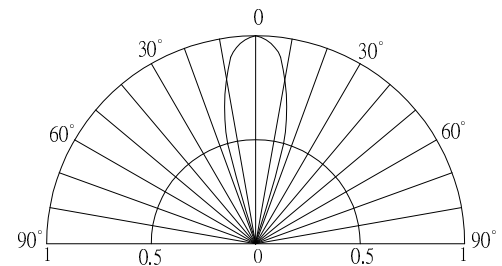
*Pulse width Max.10ms Duty ratio max 1/10

■ Directivity

■ Electrical -Optical Characteristics
(Ta=25°C)

Item	Symbol	Condition	Min.	Typ.	Max.	Unit
DC Forward Voltage	V_F	$I_F=20mA$	2.9	3.1	3.6	V
DC Reverse Current	I_R	$V_R=5V$	-	-	10	μA
Domi. Wavelength*	λ_D	$I_F=20mA$	465	470	475	nm
Luminous Intensity*	I_v	$I_F=20mA$	2180	2500	3000	mcd
50% Power Angle	$2\theta_{1/2}$	$I_F=20mA$	-	30	-	deg

*1 Tolerance of dominant wavelength is ±1nm

*2 Tolerance of luminous intensity is ±15%