

LEDTECH ELECTRONICS CORP.

5TH FL,NO.542-5,CHUNG CHENG ROAD,
HSIN-TIEN CITY,TAIWAN.

TEL:886-2-222186891

FAX:886-2-22181222,22182894

Http://www.ledtech.com.tw

SPECIFICATION

PART NO. : LT1893-91-0125

5.0mm ROUND PHOTOTRANSISTOR



Approved by

Checked by

Prepared by

Tung

Yang

Min Bao

Description

The LT1893-91-0125 is a high speed and high sensitive silicon NPN epitaxial planar phototransistor in a standard 5.0mm package. The device is sensitive to visible and near infrared radiation.

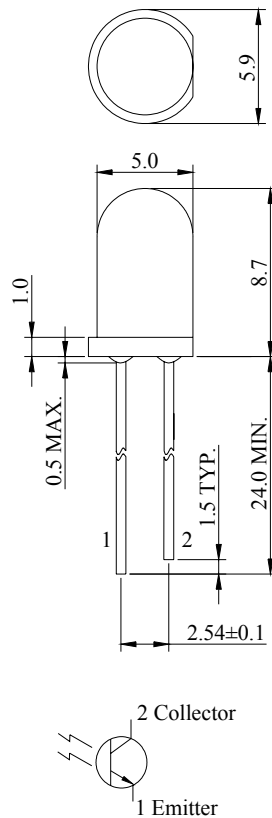

Notes:

1. All dimensions are in mm.
2. Tolerance is ± 0.25mm unless otherwise noted.

Description

Part No.	Chip	Lens Color
	Material	
LT1893-91-0125	Silicon	Water clear

Absolute Maximum Ratings at Ta=25

Parameter	Symbol	Rating	Unit
Power Dissipation	P _D	75	mW
Collector-emitter voltage	V _{CEO}	30	V
Emitter-collector voltage	V _{ECO}	5	V
Operating Temperature Range	T _{opr}	-25 to +85	
Storage Temperature Range	T _{stg}	-40 to +100	
Soldering Temperature(1.6mm from body)	T _{sol}	Dip Soldering : 260°C for 5 sec. Hand Soldering : 350°C for 3 sec.	

Electrical and Optical Characteristics:

Parameter	Symbol	Condition	Min.	Typ.	Max.	Unit
Collector-emitter breakdown voltage	V _{(BR)CEO}	Ee=0mW/cm ² I _c =100μA	30			V
Emitter-collector breakdown voltage	V _{(BR)ECO}	Ee=0mW/cm ² I _E =100μA	5			V
Collector-emitter saturation voltage	V _{(SAT)CE}	Ee=1mW/cm ² I _c =2mA			0.3	V
Rise time	T _r	V _{CE} =5V I _c =1mA		15		μS
Fall time	T _f	R _L =1000		15		μS
Collector Dark Current	I _{CEO}	Ee=0mW/cm ² V _{CE} =20V			100	nA
On State Collector Current	I _{C(ON)}	Ee=1mW/cm ² V _{CE} =5V	0.6	2.0		mA
Peak Sensitivity Wavelength	λ _P			860		nm

Typical Electrical / Optical Characteristics Curves :

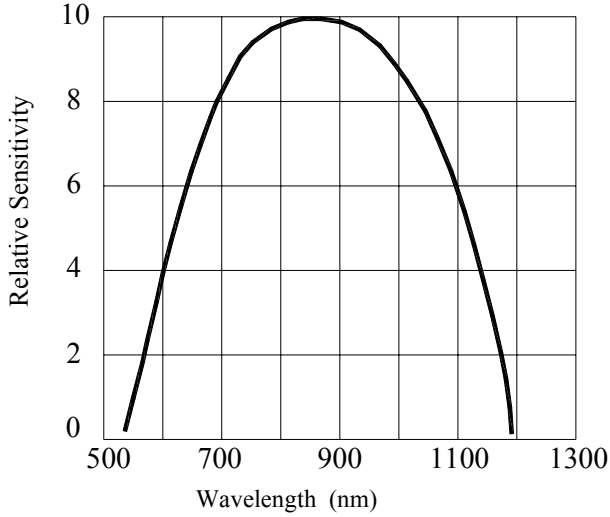

Fig. 1 Spectral Sensitivity VS. Peak Wavelength

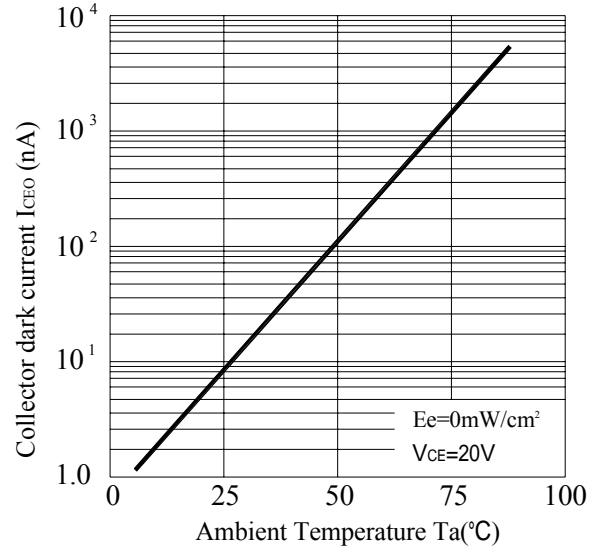

Fig. 2 Collector Dark Current VS. Ambient Temperature

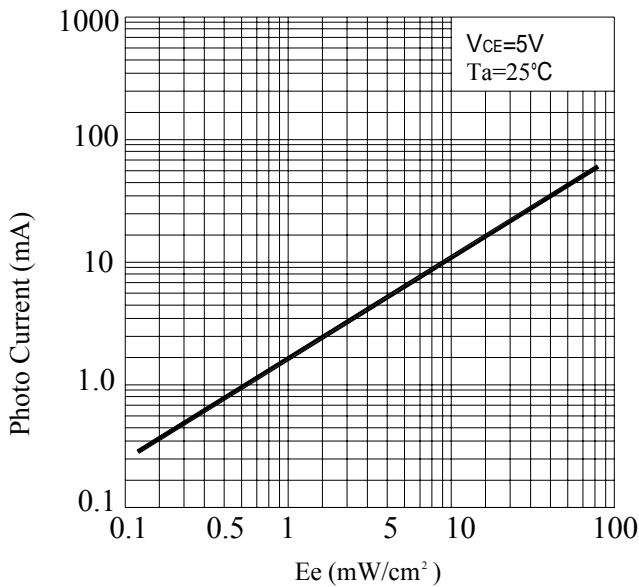

Fig. 3 Photo Current VS. Irradiance

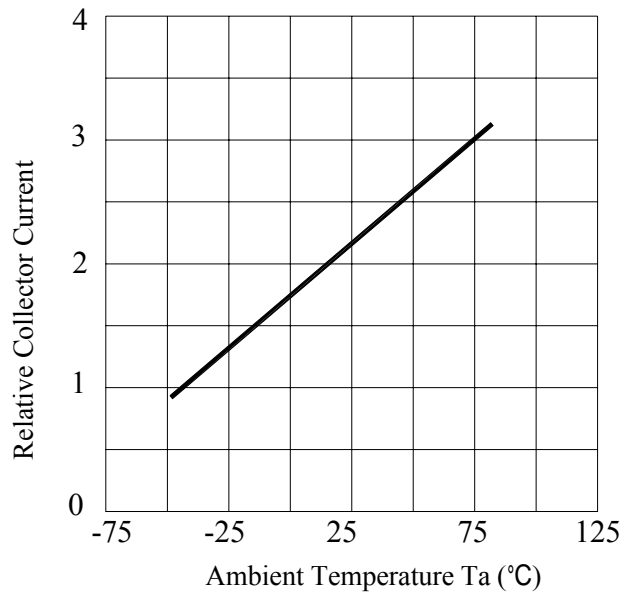

Fig. 4 Collector Current VS. Ambient Temperature

Precautions:

TAKE NOTE OF THE FOLLOWING IN USE OF LED

1. Temperature in use

Since the light generated inside the LED needs to be emitted to outside efficiently, a resin with high light transparency is used; therefore, additives to improve the heat resistance or moisture resistance (silica gel, etc) which are used for semiconductor products such as transistors cannot be added to the resin.

Consequently, the heat resistant ability of the resin used for LED is usually low; therefore, please be careful on the following during use.

Avoid applying external force, stress, and excessive vibration to the resins and terminals at high temperature. The glass transition temperature of epoxy resin used for the LED is approximately 120-130 .

At a temperature exceeding this limit, the coefficient of linear expansion of the resin doubles or more compared to that at normal temperature and the resin is softened.

If external force or stress is applied at that time, it may cause a wire rupture.

2. Soldering

Please be careful on the following at soldering.

After soldering, avoid applying external force, stress, and excessive vibration until the products go to cooling process (normal temperature), <Same for products with terminal leads>

(1) Soldering measurements:

Distance between melted solder side to bottom of resin shall be 1.6mm or longer.

(2) Dip soldering :

Pre-heat: 90 max. (Backside of PCB), Within 60 seconds.

Solder bath: 260±5 (Solder temperature), Within 5 seconds.

(3) Hand soldering: 350 max. (Temperature of soldering iron tip), Within 3 seconds.

3. Insertion

Pitch of the LED leads and pitch of mounting holes need to be same.

4. Others

Since the heat resistant ability of the LED resin is low, SMD components are used on the same PCB, please mount the LED after adhesive baking process for SMD components. In case adhesive baking is done after LED lamp insertion due to a production process reason, make sure not to apply external force, stress, and excessive vibration to the LED and follow the conditions below.

Baking temperature: 120 max. Baking time: Within 60 seconds.

If soldering is done sequentially after the adhesive baking, please perform the soldering after cooling down the LED to normal temperature.

ENCASED TYPE

PLASTIC PACKAGE
QUANTITY: 1000 PCS

LEDTECH ELECTRONICS CORP.
PART NO :LTXXXX-XX
Q'TY : PCS
LOT NO :XXXXXXXXXX
DATE :
BIN CODE:

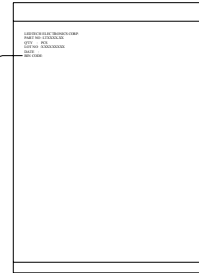

INNER BOX
QUANTITY: 10 PACKETS
TOTAL: 10,000 PCS

PART NO.	LXXXXX-XX-XX				
LOT NO.	XXXXXXXXXX				
BIN CODE	Xx X	Xx X	Xx X	Xx X	TOTAL
QUANTITY	PCS	PCS	PCS	PCS	PCS
DATE	XXXX, XX, XX				

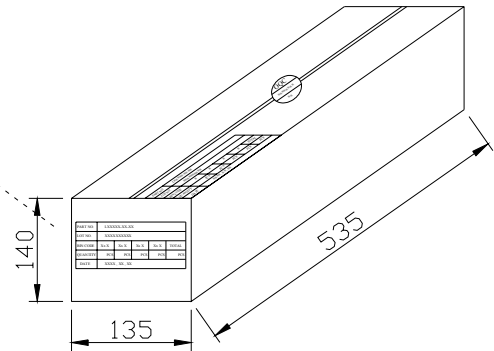

OUTER CARTON
QUANTITY: 4 BOX
TOTAL: 40,000 PCS

C/TNO. 箱號	XX
PART NO. 料號	LXXXXX-XX-XX
QUANTITY 數量	PCS
N.W. 淨重	KGS
G.W. 毛重	KGS
REMARK 備註	

