

Axial Lead Diode

Avalanche Diode

SKa 1

Features

- Avalanche type reverse characteristic
- Transient voltage proof within specified limits
- Taped for automatic insertion
- Available with formed leads on request
- Plastic material used carries Underwriter Laboratories flammability classification 94V-0

Typical Applications

- DC supply for magnetes or solenoids (brakes, valves etc.)
- Series connections for high voltage applications (dust precipitators)

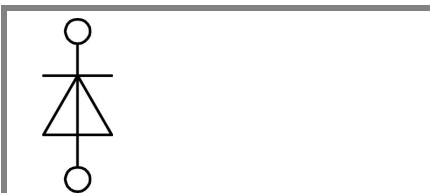

$V_{(BR)min}$	$I_{FRMS} = 3 A$ (maximum value for continuous operation)	C_{max}	R_{min}
V	$I_{FAV} = 1 A$ (sin. 180; $T_a = 60 \text{ }^\circ\text{C}$)	μF	Ω
1300	SKa 1/13	400	6
1700	SKa 1/17	200	10

Symbol	Conditions	Values	Units
I_{FAV}	$T_r = 85 \text{ }^\circ\text{C}$; $L = 10 \text{ mm}$; sin. 180	1,45	A
I_{FAV}	$T_a = 45 \text{ }^\circ\text{C}$; PCB 50 x 50 mm	1,15	A
I_{FSM}	$T_{vj} = 25 \text{ }^\circ\text{C}$; 10 ms	60	A
	$T_{vj} = 150 \text{ }^\circ\text{C}$; 10 ms	50	A
i^2t	$T_{vj} = 25 \text{ }^\circ\text{C}$; 8,3 ... 10 ms	18	A ² s
	$T_{vj} = 150 \text{ }^\circ\text{C}$; 8,3 ... 10 ms	12,5	A ² s
V_F	$T_{vj} = 25 \text{ }^\circ\text{C}$; $I_F = 10 A$	max. 1,5	V
$V_{(TO)}$	$T_{vj} = 150 \text{ }^\circ\text{C}$	max. 0,85	V
r_T	$T_{vj} = 150 \text{ }^\circ\text{C}$	max. 75	m Ω
I_{RD}	$T_{vj} = 150 \text{ }^\circ\text{C}$; $V_{RD} = V_{(BR)min}$	max. 400	μA
P_{RSM}	$T_{vj} = 150 \text{ }^\circ\text{C}$; $t_p = 10 \mu\text{s}$	1	kW
$R_{th(j-r)}$	$L = 10 \text{ mm}$	40	K/W
$R_{th(j-a)}$	PCB 50 x 50 mm	85	K/W
T_{vj}		- 40 ... + 150	$^\circ\text{C}$
T_{stg}		- 40 ... + 150	$^\circ\text{C}$
T_{sold}	max. 10 s; $L > 9 \text{ mm}$	250	$^\circ\text{C}$
V_{isol}		-	V~
a		5 * 9,81	m/s ²
m	approx.	0,5	g
Case	3500 diodes per reel	E 33	

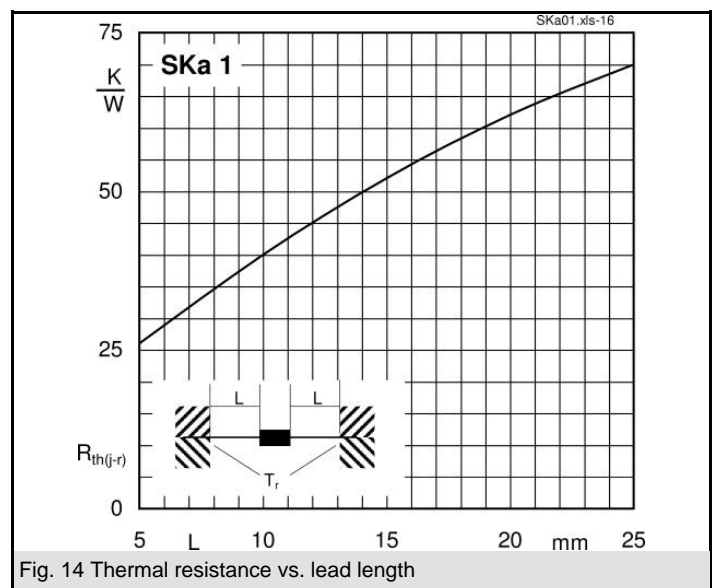
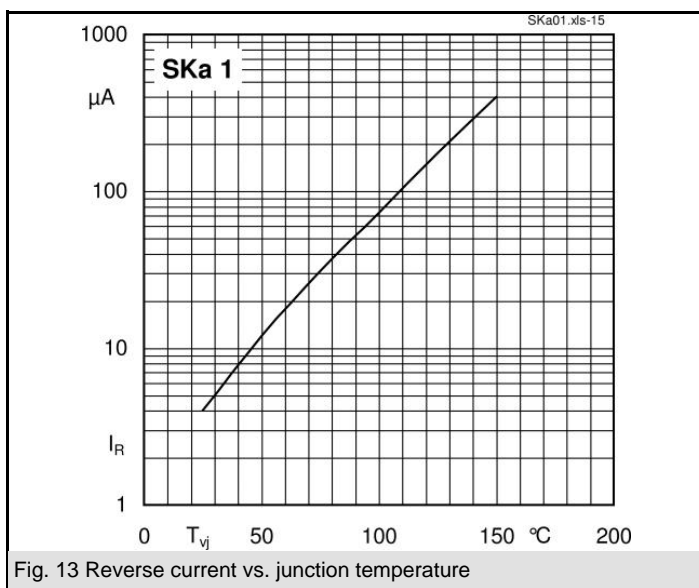
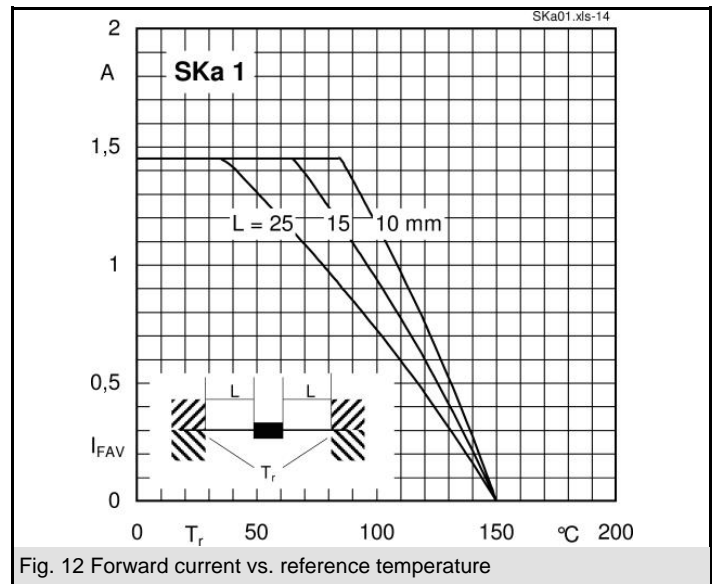
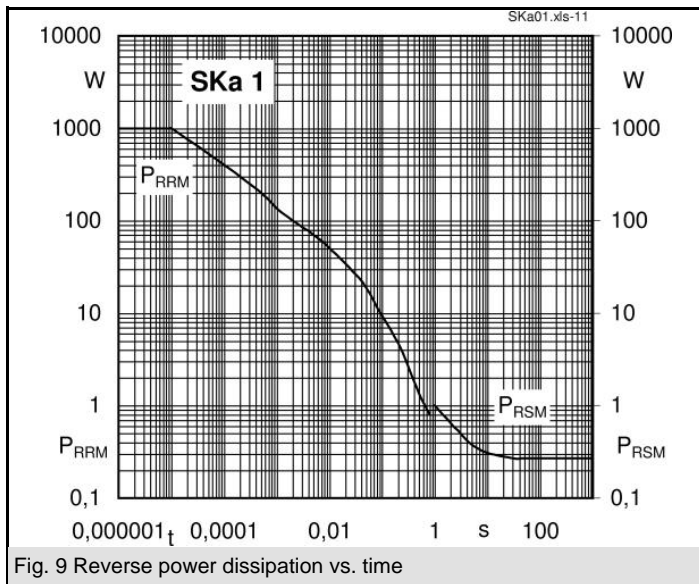
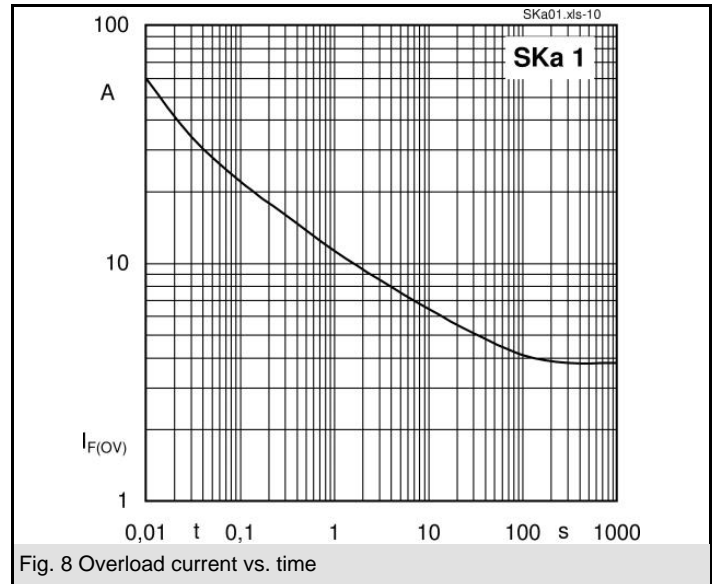
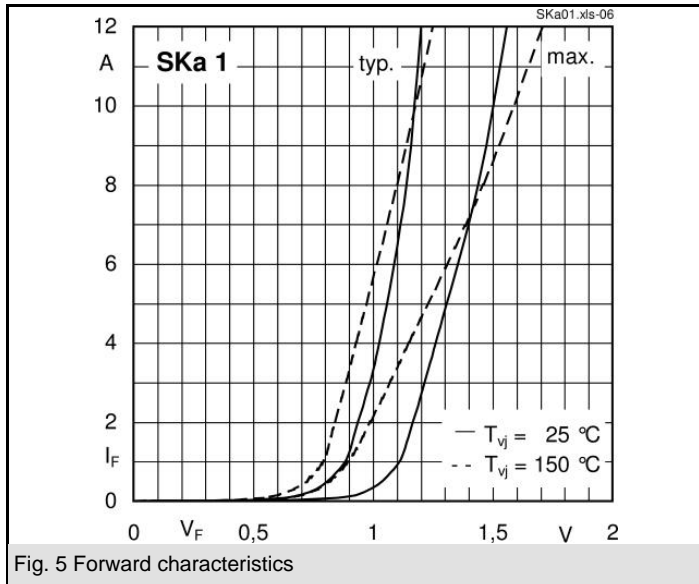

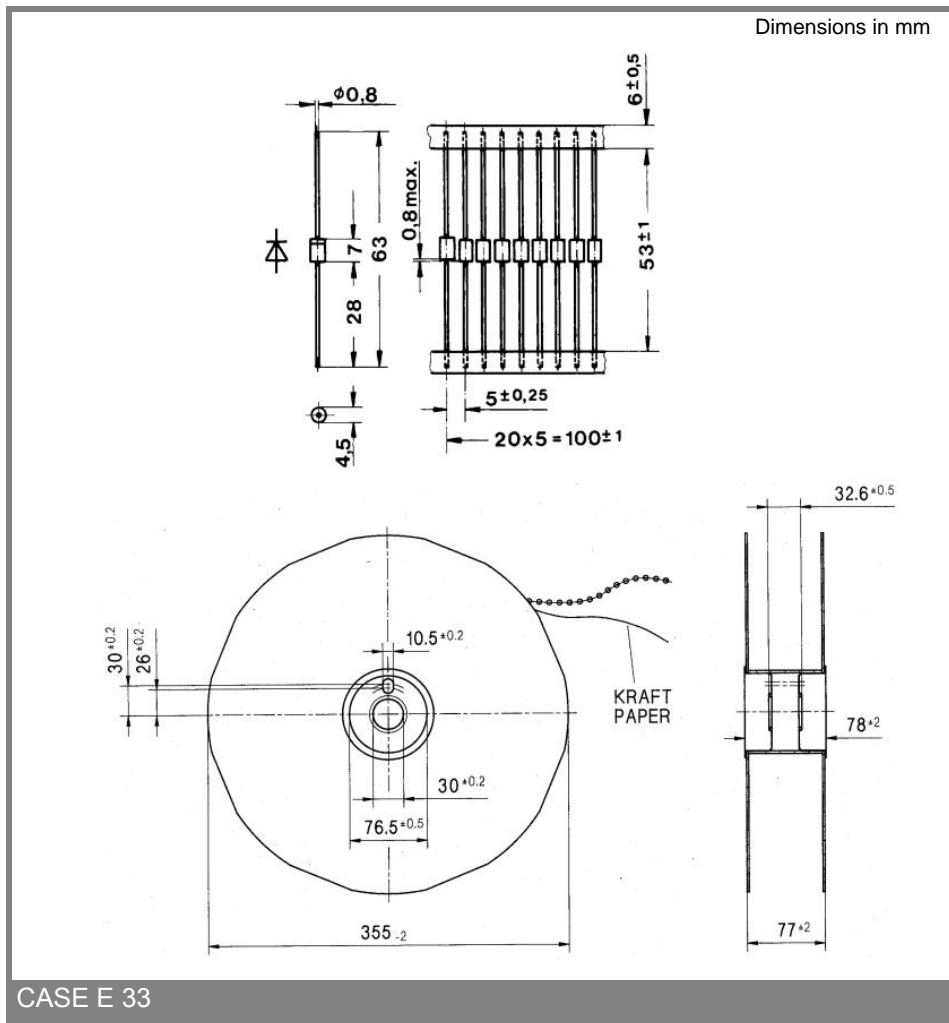

This technical information specifies semiconductor devices but promises no characteristics. No warranty or guarantee expressed or implied is made regarding delivery, performance or suitability.